



The versatility of the nozzle types presented in this chapter covers a large spectrum of applications. A modular nozzle design allows quick replacement of components as needed. The patented two-part shaft with different design features provides exceptional insulation in the front shaft area for only minimal heat loss between hot runner nozzle and cavity.

Due to their extended nozzle heads with increased heating capacity, the single nozzles of the SET, DET type are suitable for applications with thermally sensitive materials. The processing of high temperature engineering thermoplastics is now unproblematic!

All standard hot runner nozzles for multi-cavity systems can also be used for processing engineering plastics. Carbide coated nozzle tips with excellent heat conducting capabilities offer the best wear resistance in applications with filled materials (e. g. glass fibers).

Technical data	
Type	Open nozzle with tip or open nozzle with gate without tip, as a single nozzle or in a multi-cavity system.
Heating element	Pressed-in 230V heating elements; the capacity depends on the nozzle size and length; easy to exchange.
Material tube diameter	From $\varnothing 3.8$ mm to $\varnothing 16$ mm, depending on the nozzle type.
Nozzle shaft	$\varnothing 14$ mm to $\varnothing 42.4$ mm (depending on the size) Flat nozzle 4_FT nozzle shaft W1 10 mm / 22 mm 5_FT nozzle shaft W1 14 mm / 26 mm 6_FT nozzle shaft W1 14 mm / 26 mm
Nozzle length	From 30 mm to 400 mm, depending on the nozzle type.
Nozzle tip	Optionally, all nozzles can be equipped with a wear resistant hard metal tip (H).
Color change	Color change can be accelerated by using an insulating cap or nozzles of the _LT type, or by adjusting the mold stack (cavity plate screwed on at parting line). Tests prior to application are recommended in case of doubt.
Thermocouple	Measuring point close to the gate.
Thermo connection	Fixed or pluggable with flexible cable.
Power connection	Fixed or pluggable with flexible cable.
Pitch center	Starting at 14.5 mm (nozzle is reduced to size "W"), <14.5 on request.
Part weight	From 0.02 g to 5000 g depending on the material used.
max. permissible pressure	2000 bar.
Control	Single zone control: DP1 / 2 Multi-zone control: DP3 / 5, DPT5 - 15, DPT20 - 45, DPT multizone



- T = Operating voltage 230 V
- E = Single nozzle, with shaft
- F = Nozzle for extremely limited tool space
- H = Nozzle with shaft
- L = Nozzle for limited tool space, without shaft
- M = Nozzle for limited tool space, with shaft
- N = Nozzle for limited tool space, without shaft
- T = Nozzle screwed from parting line, with shaft

- S = Open nozzle with tip
- D = Open nozzle with gate without tip

$\varnothing d$ = Number code for material tube diameter

Order code: 5 S H T 50 K H S

- L = Standard nozzle length

- K = Short height of the nozzle head

- A = Nozzle piece design A - open nozzle with gate without tip
- C = Nozzle piece design C - open nozzle with gate without tip

- H = Hard metal tip

- S = Special design



1 Power and thermo connection may be bent only **once** in this area. Minimum bending radius R8.

2 **Nozzle piece design / gate design open nozzle with tip / gate design**

1. Measurement L ^{+0,02} refers to the gate diameter.

2. **Nozzle piece design A**

for open nozzle with gate without tip:

The die gap \varnothing is dependent on the gate diameter (D)

Nozzle size 4-6 = die gap of 1.5 mm

Nozzle size 8-12 = die gap of 3.0 mm

Nozzle size 16 = die gap of 4.0 mm

Gate design C for open nozzles can be recommended for the following applications:

- Intermediate gating
- Direct gating of large surface ABS parts >100 g
- Used for shear sensitive materials
- Gate vestige of 1-2 mm has to be expected

Nozzle type:

- DET,
- DFT,
- DHT,
- DLT,
- DMT,
- DNT,
- DTT

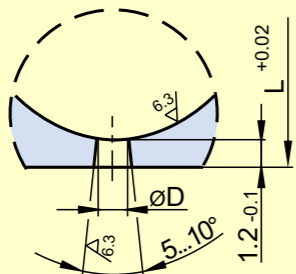

The gate diameter D is dependent on the material used and part weight.

3. **Nozzle piece design C for open nozzle with gate without tip:**
The die gap is dependent on the gate diameter (D).

3.1 **Open nozzle with tip**

The tip protrudes ΔT 250°C (325°F) 0.5 mm into the gate diameter.

Gate design A for open nozzle with tip and open nozzle with gate without tip can be recommended for the following applications:

- Gating of small POM copolymer parts
- For applications without flow lines

Nozzle type:

- SET/DET,
- SFT/DFT,
- SHT/DHT,
- SLT/DLT,
- SMT/DMT,
- SNT/DNT,
- STT/DTT

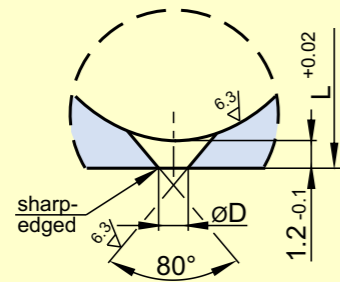

The gate diameter D is dependent on the material used and part weight. Check recommended values to determine the gate diameter D online in our "Delta Tool Calculation Program" at www.guenther-hotrunner.com.

For the gate diameter < 1.2 mm the measurement L in the mold has to be changed.

3 Recess for the screws of the gate bushing

4 Recess for the M5 screws of the nozzle heads

5 Recess for the screws of the nozzle under the manifold

6 The cable channel layout is determined by the pitch center and location.

Please note:

1. Positive seal
When the hot runner system is cold, there is no positive seal between nozzles and manifold. It is necessary to reach operating temperature in order to seal the system.
2. Hot runner nozzle
 - a. In case of limited installation space, the nozzle head can be flattened to fit the dimension W when using the following nozzle types: _HT/_LT/_MT/_NT
 - b. The hot runner nozzles of the _MT/_NT/_TT type are not screwed to the manifold .
 - c. Take care with the metal o-rings when assembling; they provide sealing when warm. The metal o-ring are to be fixed in position in the groove with some grease.
 - d. Titanium ring and metal o-ring are included in delivery. Spare parts, chapter 7.
 - e. **After every disassembly a new metal o-ring must be inserted when refitting the nozzle, chapter 7.**
 - f. To dismount the nozzle out of the cavity plate please insert a nozzle extractor tool, chapter 7.
3. Pitch centers
 - a. The minimum pitch center depends on the nozzle type. If the nozzle heads are close together than a support piece **is not necessary**.
4. Gate bushings
Gate bushings are used with open nozzles with tip and open nozzles with gate without tip, chapter 2.2.
5. High temperature application
Please call our technical consulting if you have questions about high temperature applications >320°C.
6. Dimensions and tolerances
Dimensions and tolerances given refer to the mold.
7. Please see chapter 3 (yellow page) for the heat expansion gap dimension "K".
8. Maximum tightening torque

Threads	Property class	
	10.9	12.9
M4	3.8 Nm	4.6 Nm
M5	8 Nm	9.5 Nm
M6	13 Nm	16.0 Nm
M8	32 Nm	39.0 Nm
M10	64 Nm	77.0 Nm
M12	110 Nm	135.0 Nm

9. Technical information, chapter 1.4.

Tolerance zone for the nozzle seat in the cavity plate:

Dimensions \varnothing H7	> 6...10 =	+0,015 0
	> 10...18 =	+0,018 0
	> 18...30 =	+0,021 0
	> 30...50 =	+0,025 0
Dimensions \varnothing H8	> 50...80 =	+0,030 0
	> 30...50 =	+0,039 0
	> 50...80 =	+0,046 0





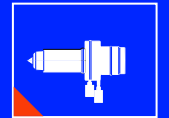

Notes

Following parts must be ordered separately, chapter 6:

1. Thermoplug CMLK
nozzle type 8-10_ET, 4-10_HT, 4-16_LT, 4-6_TT
2. Power receptacle CMT
nozzle type 8-10_ET, 4-10_HT, 4-16_LT
3. Power receptacle FKT
nozzle type 4-6_TT

If you have any questions please call our technical consulting at +49 (0) 6451 - 50 08-0.



Nozzle type	SET/DET	SFT/DFT	SHT/DHT	SLT/DLT	SMT/DMT	SNT/DNT	STT/DTT
	 Page 2.1. 20	 Page 2.1. 40	 Page 2.1. 60	 Page 2.1. 80	 Page 2.1. 100	 Page 2.1. 120	 Page 2.1. 140
Nozzle-ø	4 5 6 8 10	4 5 6	4 5 6 8 10	4 5 6 8 10 12 16	4 5 6 5K 8 10 12	4 5 6	4 5 6 8 10 12
ABS	Orange	Orange	Orange	Orange	Orange	Orange	Orange
LCP**	Orange	Orange	Orange	Orange	Orange	Orange	Orange
PA 4.6	Orange	Orange	Orange	Orange	Orange	Orange	Orange
PA 6	Orange	Orange	Orange	Orange	Orange	Orange	Orange
PA 6+V0+W*	Orange	Orange	Orange	Orange	Orange	Orange	Orange
PA 6.6	Orange	Orange	Orange	Orange	Orange	Orange	Orange
PA 6.6+V0+GF	Orange	Orange	Orange	Orange	Orange	Orange	Orange
PA 6.6+V0+W*	Orange	Orange	Orange	Orange	Orange	Orange	Orange
PA 11	Orange	Orange	Orange	Orange	Orange	Orange	Orange
PA 12	Orange	Orange	Orange	Orange	Orange	Orange	Orange
PBT	Orange	Orange	Orange	Orange	Orange	Orange	Orange
PBT+V0	Orange	Orange	Orange	Orange	Orange	Orange	Orange
PBT+V0+W*	Orange	Orange	Orange	Orange	Orange	Orange	Orange
PC	Orange	Orange	Orange	Orange	Orange	Orange	Orange
PE	Orange	Orange	Orange	Orange	Orange	Orange	Orange
PEEK**	Orange	Orange	Orange	Orange	Orange	Orange	Orange
PET	Orange	Orange	Orange	Orange	Orange	Orange	Orange
PMMA	Orange	Orange	Orange	Orange	Orange	Orange	Orange
POM copolymer	Orange	Orange	Orange	Orange	Orange	Orange	Orange
PP	Orange	Orange	Orange	Orange	Orange	Orange	Orange
PPS**	Orange	Orange	Orange	Orange	Orange	Orange	Orange
PS	Orange	Orange	Orange	Orange	Orange	Orange	Orange
PVC, soft	Orange	Orange	Orange	Orange	Orange	Orange	Orange
PVC, hard	Orange	Orange	Orange	Orange	Orange	Orange	Orange
SAN	Orange	Orange	Orange	Orange	Orange	Orange	Orange
TPE	Orange	Orange	Orange	Orange	Orange	Orange	Orange
TPU	Orange	Orange	Orange	Orange	Orange	Orange	Orange

- Suitable
- Limited suitability
- On request

* Heatstabilized, please contact us

** Only nozzles for high temperature applications, no standard version

Nozzle type

E = single nozzle with shaft

F = for extremely limited tool space, screwed to the manifold

H = screwed to the manifold with shaft

L = screwed to the manifold, without shaft

M = for limited tool space, not screwed to the manifold with shaft

N = for limited tool space, not screwed to the manifold, without shaft

T = screwed from parting line, with shaft

The nozzle size depends on the shot weight, taking into consideration pressure drop and dwell time. To confirm material/nozzle compatibility please contact our technical consulting department.

Hot runner nozzle type SMT/DMT

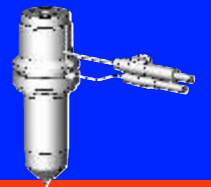

Assembly

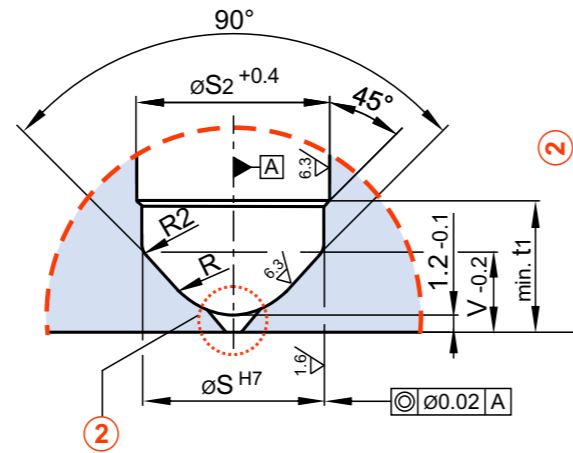
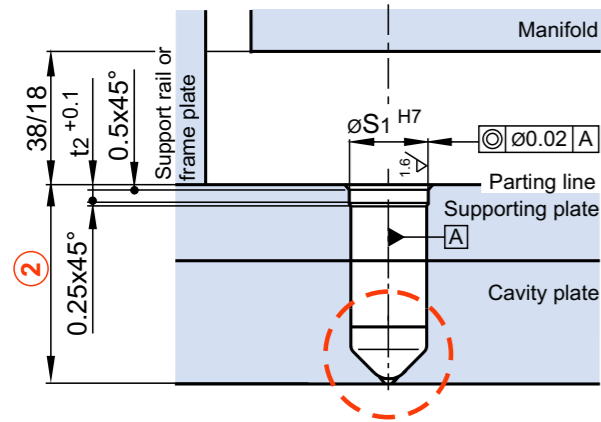

4-6SMT/-DMT View: Recess in the frame plate

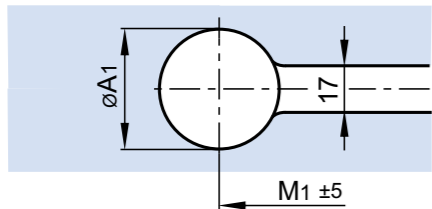

8-12SMT/-DMT View: Recess in the frame plate

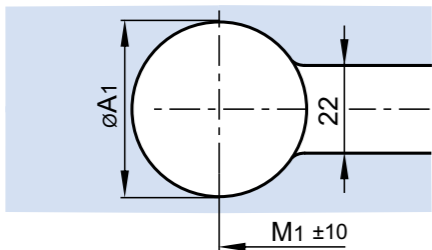

5SMTK/-DMTK View: Recess in the frame plate

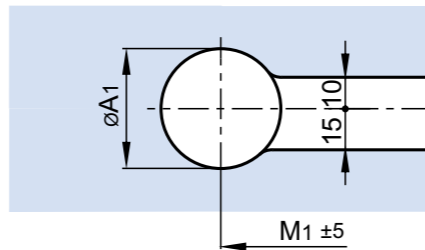

Dimensions

Nozzle type	(mm)															
	SMT/DMT	øA	øA1	øB	ød	M	M1	q1	R	øS	øS1	øS2	t1	t2	V	W
4		29.0	33	24.5	3.8	72	92	-	5	20	21	20.5	30	5	9.2	22.5
5		33.0	37	26.5	4.8	88	108	-	8	22	23	22.5	32	5	9.0	23.5
5_K		33.0	37	26.5	4.8	88	108	-	8	22	23	22.5	25	5	9.0	23.5
6		33.6	38	27.4	6.0	88	108	-	8	26	27	26.5	35	5	11.0	27.5
8		50.0	54	36.0	7.5	115	135	13	8	26	27	26.5	35	5	11.0	38.0
10		58.0	62	39.0	10.0	115	135	14	8	32	33	32.5	38	10	13.9	46.0
12		58.0	62	39.0	12.0	115	135	14	12	38	39	38.5	39	10	15.3	46.0

Order code

Example: Hot runner nozzle 5SMT60

- 5 = Material tube diameter 4.8 mm,
- SMT = Open nozzle with tip, connected with the manifold
- 60 = Length 60 mm

Please indicate the gate diameter in your order.

Notes

① as well as further technical notes on the "yellow page".

Manifold, chapter 3.



8-12SMT/-DMT

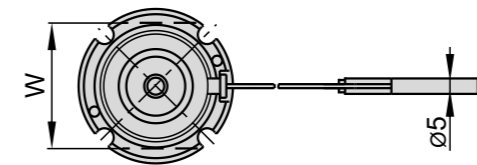
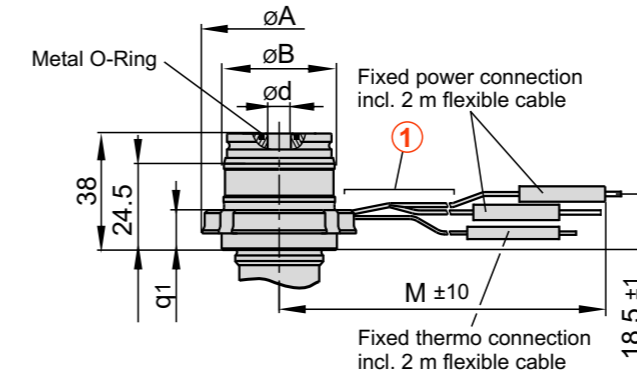

Hot runner nozzle for limited tool space, not screwed to the manifold, with shaft

4-6SMT/-DMT

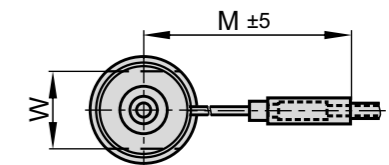
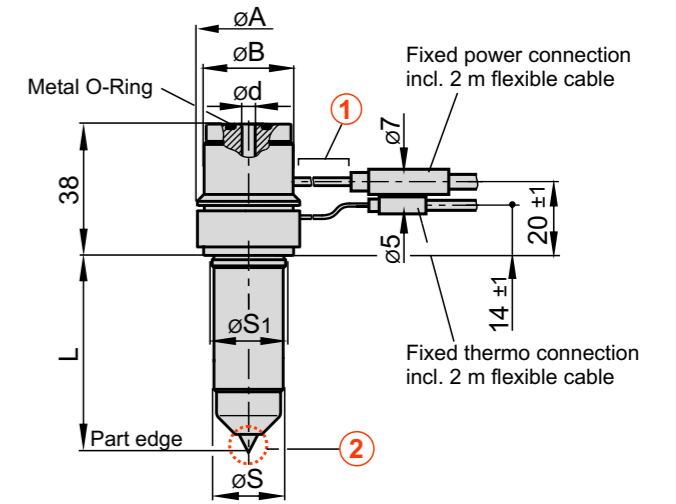

5SMTK/-DMTK

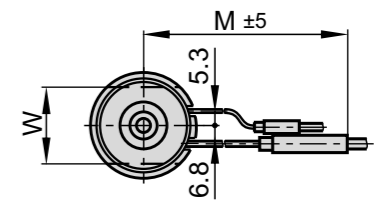
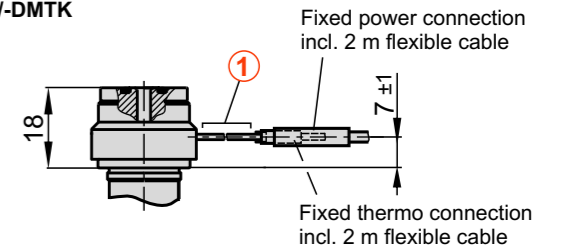

Delivery time

Nozzle type	Nozzle length L (mm)												
	SMT/DMT	30	40	50	60	80	100	120	150	200	250	300	350
4		○	●	●	●	●	●						
5		●	●	●	●	●	●	○					
5_K		●											
6		●	●	●	●	●	○	○	○	○			
8			●	●	●	●	●	●	●	●	●	●	●
10				●	●	●	●	●	●	●	●	●	●
12					●	●	●	●	●	●	●	●	●

● = in stock, ● = short delivery time, ○ = delivery time upon request